



- ✓ Height Safety Systems & Equipment
- ✓ Rescue Equipment
- ✓ Confined Space Equipment
- ✓ Accredited Training
 - ❖ Confined Space
 - ❖ Working at Height
 - ❖ Vertical Rescue
- ✓ Gas Detection
- ✓ BLH Stop Drop Barricading ~ Prevention of Dropped Objects
- ✓ MiOCS™ Electronic Pre-Start
- ✓ Trailer Edge Management Systems
- ✓ Medical Equipment
- ✓ Emergency Response Training & Equipment

Pulleyman Winch Model Number CSW-3060

MULTIPURPOSE AND PORTABLE WINCH



PULLEY MAN



Capacity 300 kg



Your one-stop Safety Solutions Provider

P: 07 4772 0241 F: 07 4772 3240 E: solutions@safeoptionsolutions.com.au

24 Ethel Street, Hyde Park. QLD 4812

www.safeoptionsolutions.com.au

ELLENAXE PTY LTD t/as *Safe Option Solutions* ABN 63 105 174 098

Use: Lifting or Pulling

- Construction & engineering sites
- Assembly & dismantling of steel structures
- Industrial plants & mines
- Electric & cable works
- Portable car winch & handy crane
- Lifting, cleaning & repair work in high buildings
- Rescue work

Technical Properties

- Can be used with all drills, cordless or not.
- Easy to set up: suspension hook.
- Small size: (3.5 kg net weight)
- Works in all positions.
- Lifting capacity: 300 kg on one fall
- Haulage capacity for loads on wheels:
 - from 450 to 1,500 kg on one fall depending on the slope.
- Cable length :
 - unlimited in traction,
 - limited to 50 m in lifting
- Automatic load maintenance system (patented self-braking brake reducer).
- Supplied as standard with 12 m of cable (aviation type Ø 4.76 mm galvanized steel cable).



Lifting of manhole-cover in connection with a tripod



Fixed at the tripod, using an adapter plat with stop ring



A helpful device in the forestry



Very short design height

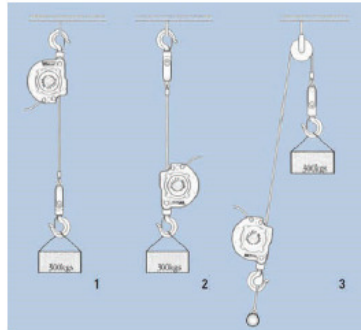

1 – Single fall – Winch at the top 2 – Single fall – Winch at the bottom 3 – Single fall – Winch in the middle

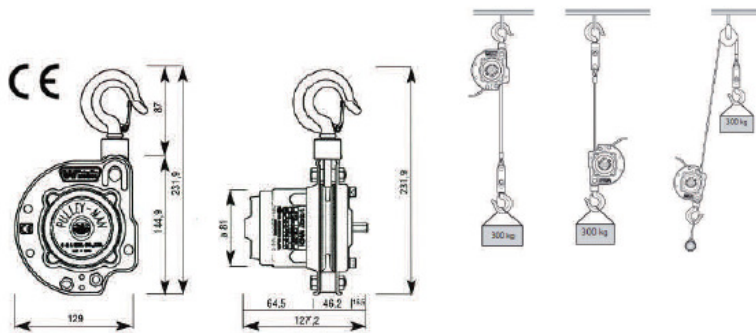

	No. of falls	Single line
Pulling capacity	6°	1,500
	12°	975
	16°	825
	27°	585
	35°	990

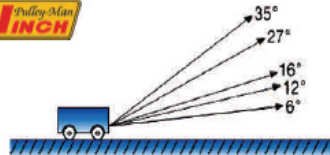

Power Source	Hand Drill	220V / 1 f, 550W, 3000rpm (Max), Reversible
	Cordless Drill	3/8" (10mm), 12/9.6V DC, Max Torque above 230in./lbs, Reversible
Options	DC Motor	DC 12V, 3000rpm (Max), Reversible
Any other compatible motor with 3000rpm (Max), Reversible.		

Pricing	+ GST
Pulleyman Hoist Part Number CSW-3060	\$1071.00
Conversion Sheave to convert winch from 300kg to 600kg Part Number CSW-3060-DL	\$238.00
12 metre wire rope Part Number CSW-3060-12M	\$173.60
20 metre wire rope Part Number CSW-3060-20M	\$207.20
30 metre wire rope Part Number CSW-3060-30M	\$229.60
50 metre wire rope Part Number CSW-3060-50M	\$294.00
Bottom Hook Part Number CSW-3060-BH	\$176.40
Gear Package Part Number CSW-3060-GP	\$466.20
Hook Latch Part Number CSW-3060-HL	\$16.10
Press Roller Casings Part Number CSW-3060-PRC	\$194.04
Upper Hook Part Number CSW-3060-UH	\$134.96

**For further details contact Loretta Reid Phone 0438 734895
or email loretta@safeoptionsolutions.com.au**